

4

3

2

1

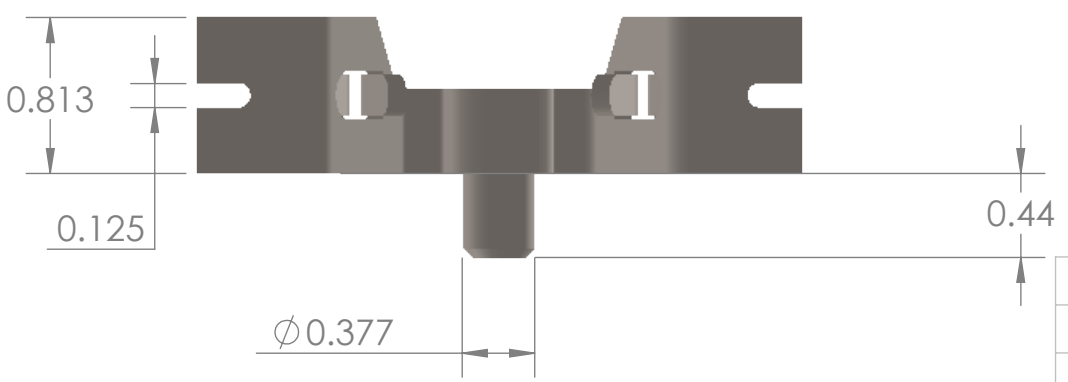
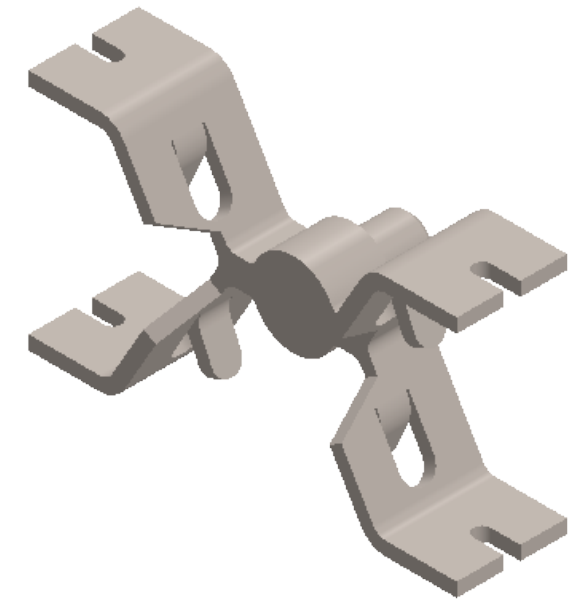
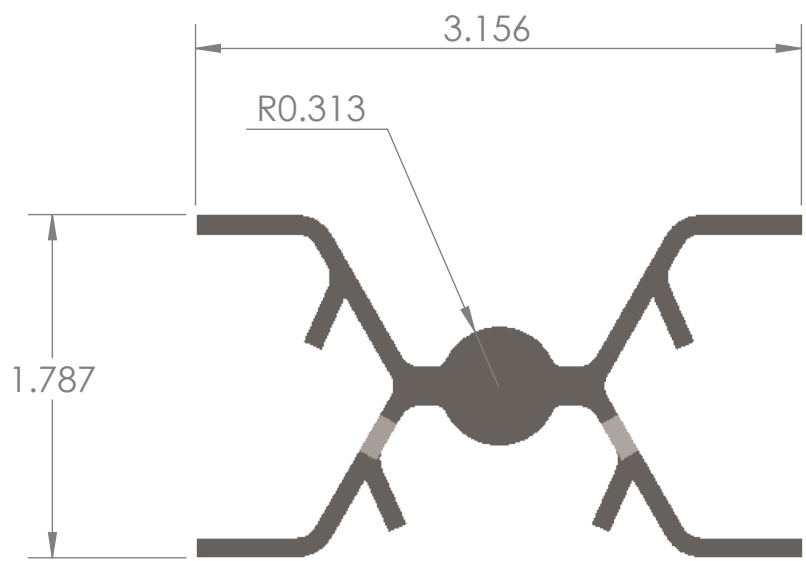

PROPRIETARY AND CONFIDENTIAL
 THE INFORMATION CONTAINED IN THIS DRAWING IS THE SOLE PROPERTY OF MALCO. ANY REPRODUCTION IN PART OR AS A WHOLE WITHOUT THE WRITTEN PERMISSION OF MALCO IS PROHIBITED.

		UNLESS OTHERWISE SPECIFIED:		NAME	DATE			
		DIMENSIONS ARE IN INCHES		DRAWN	MW	3/9/26		
		TOLERANCES:		CHECKED			TITLE:	
		FRACTIONAL \pm		ENG APPR.			 MALCO	
		ANGULAR: MACH \pm BEND \pm		MFG APPR.				
		TWO PLACE DECIMAL \pm		Q.A.			SIZE DWG. NO. REV	
		THREE PLACE DECIMAL \pm		COMMENTS:			B SpeedHex 28 0	
		INTERPRET GEOMETRIC TOLERANCING PER:					SCALE: 1:1 WEIGHT: SHEET 1 OF 1	
		MATERIAL						
		Steel						
		FINISH						
NEXT ASSY	USED ON							
APPLICATION		DO NOT SCALE DRAWING						

4

3

2

1

B

B

A

A

4

3

2

1

B

B

A

A

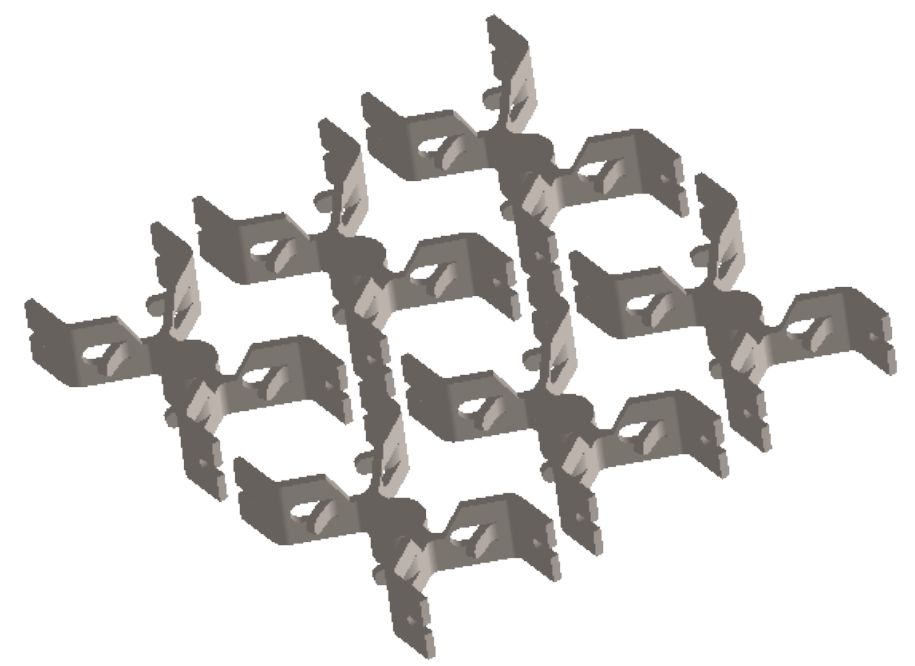
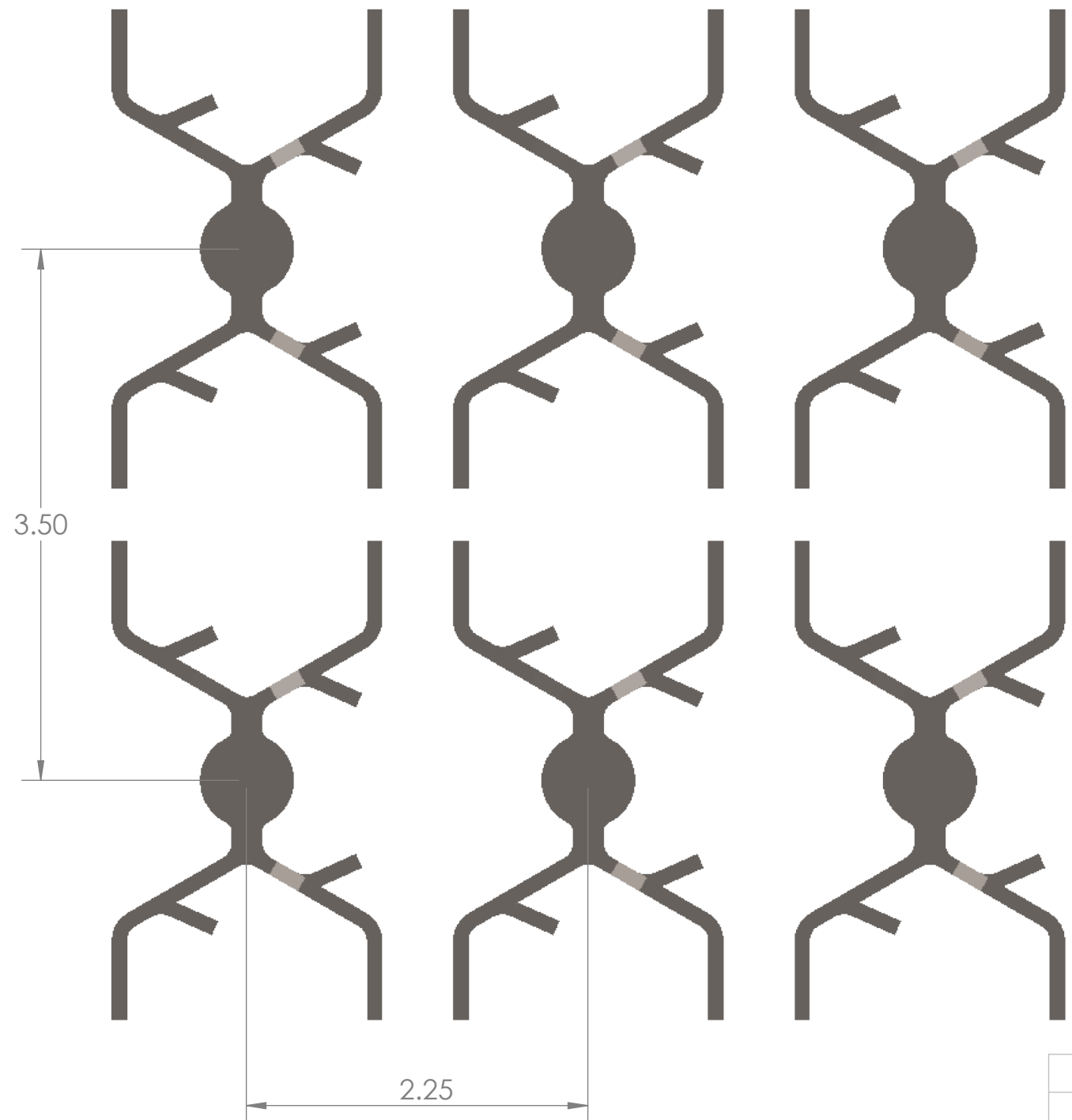

SPEED HEX 28 ASSEMBLY 12

PROPRIETARY AND CONFIDENTIAL
 THE INFORMATION CONTAINED IN THIS DRAWING IS THE SOLE PROPERTY OF MALCO. ANY REPRODUCTION IN PART OR AS A WHOLE WITHOUT THE WRITTEN PERMISSION OF MALCO IS PROHIBITED.

		UNLESS OTHERWISE SPECIFIED:		NAME	DATE		
		DIMENSIONS ARE IN INCHES		DRAWN	MW	3/16/26	TITLE:
		TOLERANCES:		CHECKED			
		FRACTIONAL ±		ENG APPR.			
		ANGULAR: MACH ± BEND ±		MFG APPR.			
		TWO PLACE DECIMAL ±		Q.A.			SIZE DWG. NO. REV B SpeedHex 28 Assy 12 0
		THREE PLACE DECIMAL ±		COMMENTS:			
		INTERPRET GEOMETRIC TOLERANCING PER:					SCALE: 1:1
		MATERIAL		Steel			WEIGHT:
		FINISH					SHEET 1 OF 1
NEXT ASSY	USED ON	APPLICATION		DO NOT SCALE DRAWING			

4

3

2

1

4

3

2

1

B

B

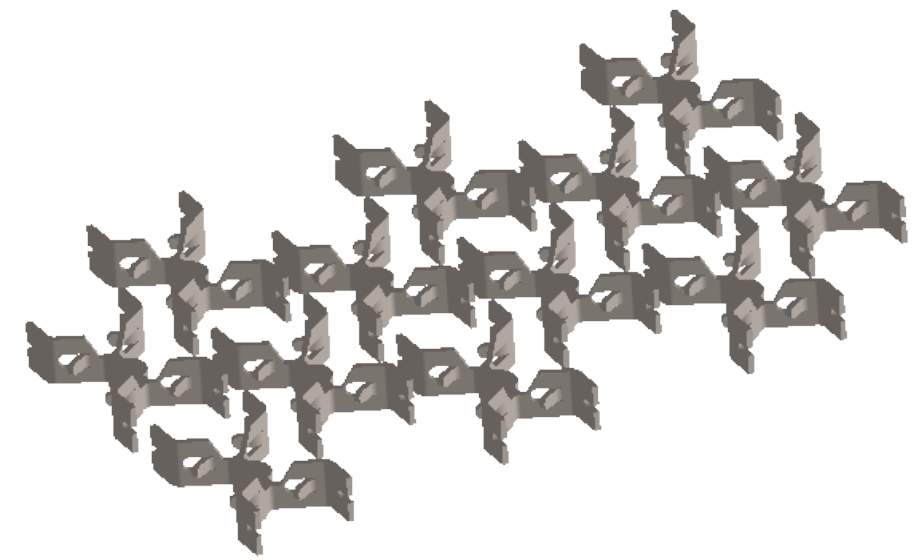
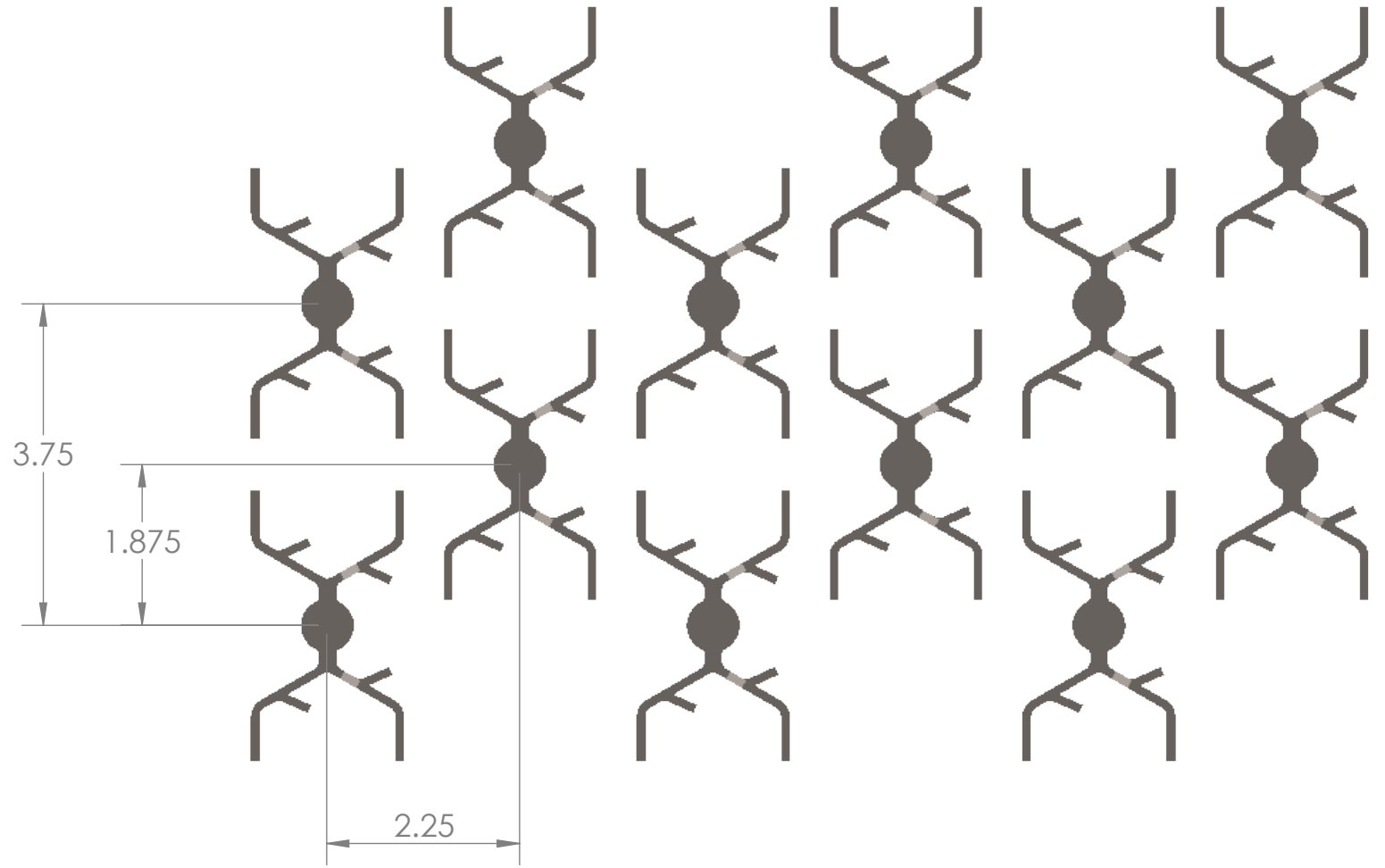

A

A

SPEED HEX 28 ASSEMBLY 13

PROPRIETARY AND CONFIDENTIAL
 THE INFORMATION CONTAINED IN THIS DRAWING IS THE SOLE PROPERTY OF MALCO. ANY REPRODUCTION IN PART OR AS A WHOLE WITHOUT THE WRITTEN PERMISSION OF MALCO IS PROHIBITED.

		UNLESS OTHERWISE SPECIFIED:		NAME	DATE
		DIMENSIONS ARE IN INCHES		DRAWN	MW 3/16/26
		TOLERANCES:		CHECKED	
		FRACTIONAL ±		ENG APPR.	
		ANGULAR: MACH ± BEND ±		MFG APPR.	
		TWO PLACE DECIMAL ±		Q.A.	
		THREE PLACE DECIMAL ±		COMMENTS:	
		INTERPRET GEOMETRIC TOLERANCING PER:			
		MATERIAL			
		Steel			
		FINISH			
NEXT ASSY	USED ON				
APPLICATION		DO NOT SCALE DRAWING			
		TITLE:			
SIZE	DWG. NO.	REV			
B	SpeedHex 28 Assy 13	0			
SCALE: 1:2		WEIGHT:		SHEET 1 OF 1	

4

3

2

1